

What Children's Pause Patterns Indicate about their Constituent Structure

Erin M. Maloney, Doris L. Payne, and Melissa A. Redford

1. Introduction

The mainstream view of language production has encouraged researchers to regard the acoustic correlates of prosody, such as final lengthening and pausing, as reflective of the existence of higher order linguistic structures or units (Cooper & Paccia-Cooper, 1980; Ferreira, 1988; Selkirk, 1984; Wagner, 2005; Watson & Gibson, 2004). For example, Cooper & Paccia-Cooper (1980) used measures of final lengthening to argue that language formulation plans make use of certain syntactic constituents, as opposed to others. They also argued that pause duration positively correlates with syntactic boundary strength, and that the longer pauses found at major constituent (clause) boundaries result from "processing fatigue" brought on by the demands of producing the previous syntactic sub-constituents. Other studies have examined speech for evidence of constituent movement and gaps posited by Transformational Grammar (Chomsky, 1965). For example, Ferreira (1988) showed that the presence of a gap in surface structure affects whether a preceding word is reduced or lengthened. She argued that a trace blocks the normal process of vowel reduction in words like *to* in sentences like *The boy_i was spoken t_Q (t_i) by his teacher.*

Central to such theories of language production is the view that grammar is hierarchically organized, and that the evidence from speech reflects this organization. Traditional structuralist as well as Generative theories of syntactic structure (e.g. Hockett, 1958; Chomsky, 1957; 1965; Kayne, 1994) provide models of the hierarchical organization of constituents. These models allow for specific hypotheses about where to pause in an utterance (and, perhaps, for how long). As Radford (1988) puts it,

...Sentences are not just unstructured sequences of sounds; rather, they have a hierarchical *constituent structure* in which sounds are grouped together into words, words into phrases, and phrases into sentences (p. 109, his emphasis).

Constituents are words or phrases, belonging to specific syntactic categories, typically represented in the form of phrase markers ('trees'), in which sets of points (different *nodes*) are labeled according to the category they represent. For instance, in the following phrase marker, certain relations are made explicit:

* Erin Maloney, University of Oregon, maloney3@uoregon.edu.

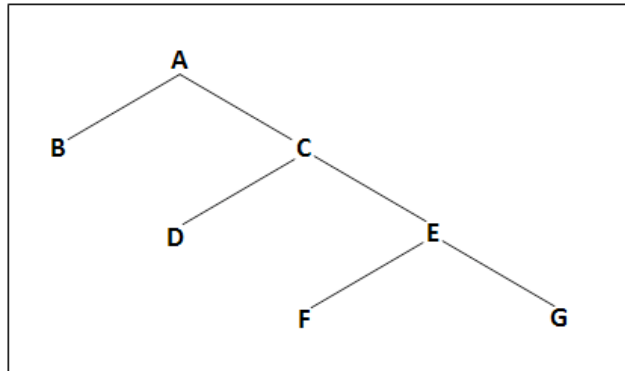

Figure 1. Phrase Marker diagram following Radford (1988).

With the assumption that such Phrase Markers exist, the process of language production unfolds as such: after a speaker generates an idea that is translated into linguistic form as a semantic representation, the speaker then formulates a partial grammatical representation of the utterance. Then, the speaker chooses lexical items in an order that is informed by the grammatical structure, e.g. first the head noun of the subject noun phrase might be inserted at node B. Following this selection, the rest of the grammatical representation of the phrase to be uttered is fleshed out in nodes D, F and G with modifiers of the subject and other lexical items for newly elaborated categories (Cooper & Paccia-Cooper, 1980). The computation of the grammatical structure, according the Coopers, proceeds from the top down and within each hierarchical level, from left to right (p. 3), analogous to the system of phrase structure proposed by Chomsky (1957). Hence, if we were to re-draw Figure 1 as representative of the sentence *Frog ate a fly*, we would have the Phrase Marker in Figure 2.

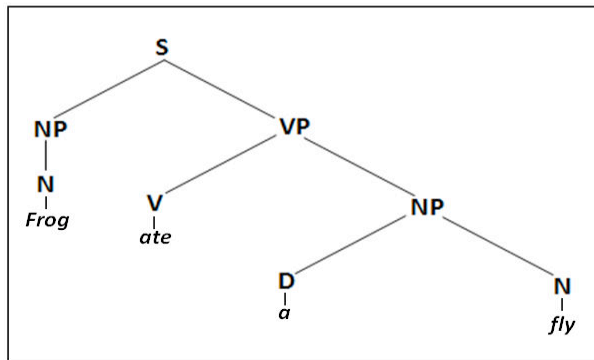

Figure 2. Grammatical representation of the phrase *Frog ate the fly* following Phrase Marker notation.

Thus, possible sites for pauses within clauses exist between nodes, either within constituents or at constituent boundaries. Previous pause research (cf. Cooper & Paccia-Cooper, 1980; Ferreira, 1991; McKee & McDaniel, 2001) indicates that the strongest syntactic boundary should be the most likely pause site for speakers; more deeply embedded, weaker boundaries should be the least likely pause sites. With respect to hypothesized constituency, the putatively strongest boundary corresponds to the longest spanning constituent in English, which comprises most (if not all) of the sentence; it might be thought of as the most “grammatically appropriate” place to pause. Put differently, a pause at the subject NP/V juncture is a pause between the least-embedded constituents in the sentence. The second-strongest boundary occurs within the VP constituent,

between the head verb and the NP that the VP dominates. This pause site is grammatically “less-appropriate”, since the spanning constituent is smaller and more deeply embedded into the sentence. Finally, the weakest syntactic boundary, the within-NP boundary, occurs between determiner (or less often, adjective) and the head noun, within the smallest, most embedded, and perhaps the most tightly-unified syntactic unit according to traditional theory (cf. Radford 1988).

Despite an extensive body of research on the interface between syntax and prosody in English-speaking adults, not much research has examined this interface in children’s spoken language. An exception is a study by McDaniel and colleagues (McDaniel, McKee, Garrett, 2010) that investigated pauses and other disfluencies in child and adult language in order to evaluate the similarities and differences in syntactic representation and planning in the two groups. Specifically, they used a relative clause elicitation task, manipulating the relativized NP (subject NP or predicate NP) and the depth of clause embedding, in order to tax sentence planning mechanisms in a filler-gap construction. For instance, a *short-subject NP* relative clause response might be *Pick up the robber that ___ is touching the dog*, whereas a *long-predicate NP* relative clause response was *Pick up the duck that Big Bird thinks the princess was kissing ___*. They measured hesitation phenomena (silent pauses, filled pauses, restarts) in each of the four conditions for adults, younger children (ages 3-5), and older children (ages 6-8) and found remarkable similarities across the age groups—suggesting that the response to processing demands roughly corresponds for children and adults. Specific differences were also found. Children (both older and younger) showed less hesitation with the short, rather than long, sentences. Adults had less hesitation with the subject-NP filler-gap structures, rather than the object filler-gap structures. Moreover, children more often used an overt complementizer (*that*) ungrammatically in long-subject NP-relativized sentences (**The queen that Grover dreamed that was washing the pig.*) McDaniel et al. interpreted these specific differences as evidence for children processing sentence detail more locally, or in smaller chunks.

Given what we know about adult language production models, prosodic rhythm—and more specifically, pause patterns—are influenced not only by processing load, but also by grammatical organization into constituent structure. Therefore, we questioned to what degree constituent structure in children’s language influences pausing, and if, as McDaniel et al. (2010) found, children’s pause patterns are quite similar to adult pause patterns. On the other hand, if children’s pause patterns differ, we could have reason to believe children’s language production is less influenced by grammatical structure.

In order to measure the effect of constituent structure, we will evaluate boundary strength at constituent boundaries as determined by analysis of a simple Phrase Marker. We aim to examine how stronger vs. weaker boundaries affect both child and adult pause patterns. Furthermore, we will conduct our analysis for two different child age groups—younger and older—to determine to what degree child development contributes to differences in pausing during storytelling. We expect that we will see a difference between children’s pause patterns and adults’ pause patterns simply because children are known to pause more frequently than adults (Redford, 2012). More importantly, however, we anticipate that there will be a difference in boundary strength effects for younger and older children, in addition to differences between children and adults, due to developmental changes in cognitive processing resources and younger children’s inability to hold as much information in memory. If children do plan in smaller chunks as McDaniel et al. (2010) suggest, then they will not be able to formulate large, nested constituents, and might therefore be less sensitive to differing boundary strength.

2. Method

2.1. Participants

Thirty-two children and their caregivers were recruited by word of mouth and through local elementary schools to provide short, spoken narratives. The children included 16 typically developing 5-year-olds (5;2 to 5;8) and 16 typically developing 7-year-olds (7;2 to 7;8).

Seven of the 5-year-olds were female, and 9 of the 7-year-olds were female. Two of the caregivers were male and the rest were female. All participants were native speakers of American English.

2.2. Narrative Speech Sample Collection

Spontaneous, structured narratives were collected in the Speech and Language lab at the University of Oregon. Participants were shown four wordless picture books by Mercer Mayer, which depicted different adventures of a boy, his dog, and a frog. The child and adult were instructed to each pick the story they would most like to narrate. During a planning phase, the child flipped through the pages of his chosen story with a research assistant, while the adult silently familiarized herself with her own book's story line. The research assistant ensured that the child looked at every page of the story, and drew the child's attention to important actions and character emotions according to pre-determined locations in the book by asking the child, "What's happening here?" or, "What do you think he's feeling?" The main purpose of the planning phase was to encourage both adults and children to conceptualize their stories before telling them.

Then, both the child and adult were instructed to tell their book's story to each other, alternating turns. The participant who was not telling the story was encouraged to quietly listen without interrupting the other. The storyteller wore a lavalier microphone affixed to a hat to minimize clothing-generated noise. The first story-teller was randomly decided by the adult and child at the time, and each participant told the story twice. Participants rarely changed the content of their stories from one telling to the next. Any changes were constrained to minor details (e.g. character 'names') since the story was guided by the same illustrations from one telling to the next. The narratives were digitally recorded and later transcribed for both children and adults. Sixteen adults, eight randomly chosen from each child age group, were chosen for story analysis.

2.3. Acoustic Segmentation & Grammatical Coding

The story-telling task resulted in 64 stories from children and 32 stories from adults. The recordings were displayed in Praat (Boersma & Weenink) as time-aligned oscillograms and spectrograms and then hand-segmented into (silent) pauses and utterances according to strict acoustic criteria (see Redford, 2012, for the complete criteria). In the transcriptions, pauses were indicated with slashes, as in the following excerpt:

once there was a frog / and / he is hiding under a hat / a little boy / had
a package / he looked inside / the turtle was surprised / the / dog was /
happy / and the / little boy was happy / and the frog was angry / and he
/ he looked inside / and there was a frog / then / the little boy was /
introducing him to his little / to his / friends / the turtle was happy / the
dog was happy and / the / little boy was happy the / big frog was mad
and / the / i mean angry

Independent of the acoustic analysis, a subset of sentence data was selected from each story transcription that fulfilled the following criteria: each sentence a) contained an overt subject and b) at least one predicate noun phrase (NP). A total of 3,396 words comprised the 5-year-olds' sentence data set, or about 47% of their total words spoken. A total of 4,838 words comprised the 7-year-old sentence data, or about 55% of their total words spoken. The total number of analyzed sentences for 5-year-olds was 447, with an average of 14.0 analyzed sentences per story. The total number of analyzed sentences for 7-year-olds was 596, or 18.6 analyzed sentences per story. Of the adult stories chosen for analysis, a total of 4,956 words, or 42% of their total words, corresponded to 618 sentences with the required characteristics, with an average of 19.3 such sentences per story. These figures are summarized in Table 1 below.

Table 1. Story Data Descriptives.

Age Group	Story Total	Total Analyzed Sentences	Average Analyzed Sentences/Story
5-year-olds	32	447	14.0
7-year-olds	32	596	18.6
Adults	32	618	19.3

Within the subset of analyzed sentences, pauses were counted if they occupied one of three particular grammatical locations. These grammatical locations were chosen based upon hypotheses about differing syntactic boundary strength within the traditionally-assumed English sentence structure explained above (an overt subject and at least one predicate NP). Boundary strength was ranked by counting the number of non-terminal nodes in the smallest constituent spanning a boundary (see, e.g., Abney, 1992 and Figure 3).

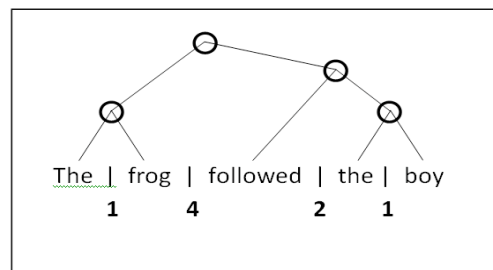

Figure 3. Hypothesized boundary strength by number of nodes.

In descending order of assumed strength, the three boundaries (indicated by '/') that we analyzed were: (1) Subject-NP/V juncture, (2) V/Predicate-NP juncture, (3) Within-subject NP and Within-predicate NP boundaries (see Figure 4). (Note that candidate NPs had to include more than one word.)

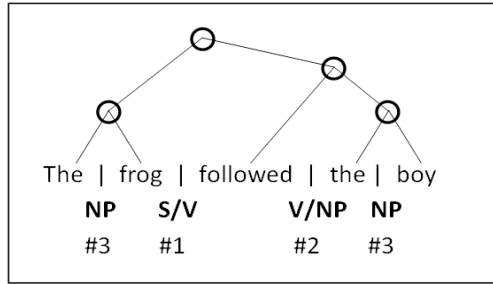

Figure 4. Relative boundary strength at chosen grammatical locations.

For the present project, we did not count pauses that occurred within the verbal unit (e.g., after the auxiliary, or between a phrasal verb and its particle); previous statistical analysis on pilot data showed no statistically significant difference between pauses at either of these sites within the verbal unit, and further consideration was not necessary for our focus on varying syntactic boundary strength. We also did not count pauses that occurred after a pronominal subject NP with a cliticized auxiliary (e.g., *he's*), in order to avoid counting a pause that could be construed as a site within the verbal unit. We did not count pauses within a complement clause, unless such a clause contained its own overt subject, verb, and predicate NP.

3. Results

We used a mixed effects model to assess the effects of age and boundary strength on pause frequency. Pause frequency was calculated per participant and per story as the proportion of observed pauses at a particular boundary site (e.g., Subj/V) divided by the number of those boundary sites. The model included speaker and story (first or second) as random factors, and the number of sentences per story as a random covariate. An analysis of pause frequency in younger and older children's storytelling indicated main effects of age [$F(1, 62) = 12.47, p = .001$] and boundary strength [$F(2, 124) = 4.19, p = .017$], but no interaction between age and boundary strength (see Figure 5).

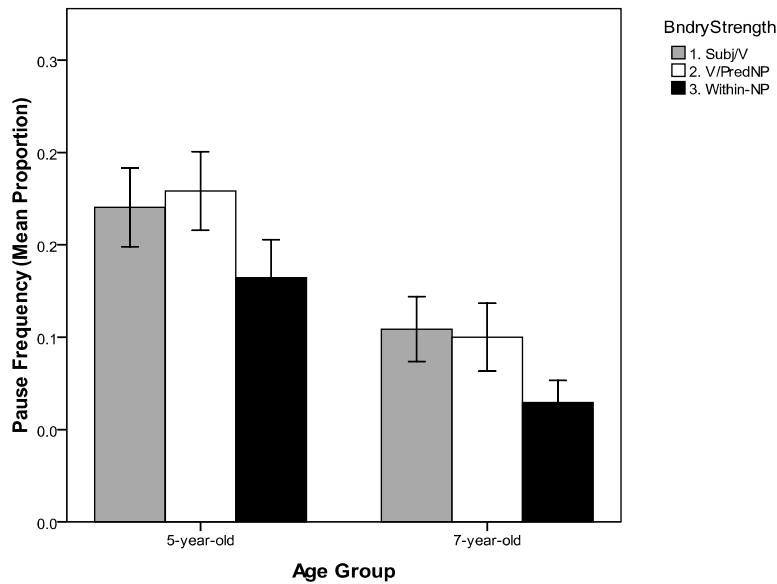

Figure 5. Pause frequency by boundary strength in younger and older children's storytelling.

The data were collapsed across age groups, and post hoc pairwise comparisons were made to further investigate pause frequency at different boundary locations. The comparisons indicated a significant difference in pause frequency between the first and third strongest boundaries (Subject NP/V versus Within NP, $p = .018$), and between the second and third strongest boundaries (V/Predicate NP versus Within NP, $p = .026$), but no difference between the first and second strongest boundaries ($p = \text{NS}$). Figure 5 shows the direction of these effects. Pause frequencies were higher at Subject/V and V/NP boundaries than at within NP boundaries.

Next, we tested for differences in the pausing behavior of children and adults. Again, the analysis indicated an effect of age [$F(2, 77) = 16.84$, $p < .001$] and of boundary strength [$F(2, 154) = 4.75$, $p = .010$]. The interaction between age and boundary strength was not significant (see Figure 6).

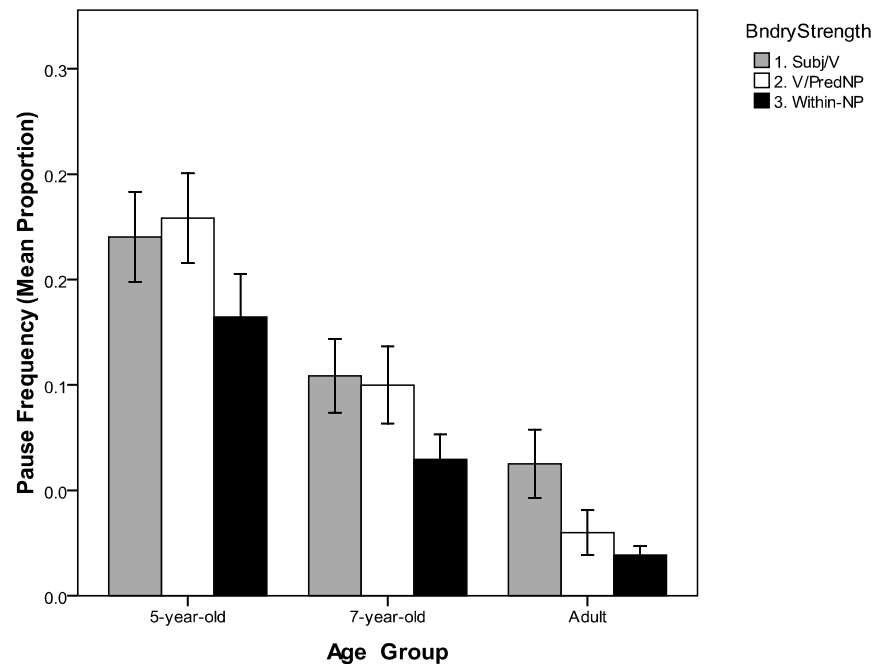

Figure 6. Pause frequency by boundary strength in child and adult storytelling.

Although the interaction between age and boundary strength was not significant, the data shown in Figure 6 suggest a different pattern of results for adults compared with children. Specifically, like children, adults appear to pause most frequently at a Subj/V boundary, but, unlike children, they pause infrequently at a V/Predicate NP boundary. Post hoc tests confirm that the differences between the first and second strongest boundaries in adult story telling was significant (Subject-NP/V versus V/Predicate- NP, $p = .048$), and that the difference between the first and third strongest boundary was significant (Subject-NP/V versus Within-NP, ($p = .010$), but that there was no difference in pause frequency between the second and third strongest boundaries (i.e., V/Predicate- NP versus Within-NP).

4. Discussion

As the analysis shows, 5-year-olds pause much more frequently at within-clause boundaries than 7-year-olds, who pause more at these boundaries than

adults. Setting aside the sheer volume of pauses that children produce as opposed to adults, pause patterns are similarly mirrored in the three groups, especially among 5-year-olds and 7-year-olds. However, these patterns are less variable in older children and adults; we can see a more clearly-defined influence of Boundary Strength in adult pause frequencies.

All speakers pause less at the weakest boundary than at the stronger ones; but, in children, pausing between subject and verb, and between the verb and predicate NP is equally likely, even though these junctures are hypothesized to have different boundary strengths in the traditional model of English syntactic structure. Moreover, pausing prior to the predicate NP and within an NP in adults is equally likely, even though these junctures have different theoretical boundary strengths. As a result, younger children’s pause frequencies do not appear to be influenced by any grammatical constituent structure, as measured by Boundary Strength.

4.1. Boundary Strength and Constituency Effects on Pausing

The general mirroring of pause patterns from younger children, to older children, to adults resembles McDaniel et al.’s (2010) finding of remarkably similar pause tendencies among groups. Children must be responding to the same processing demands of the story-telling task as adults. In addition, the sheer amount of child pauses also suggests that children stop and plan sentence units much more frequently, also supporting McDaniel et al.’s hypothesis that children process sentences in smaller chunks.

However, children’s pause patterns do not confirm any influence of an asymmetrical *hierarchical* constituent structure (cf. Figure 2). The frequency with which children pause between the verb unit and predicate NP shows that the predicate NP is not a part of the VP, or it is not ‘dominated by’ the verb node. Thus, if we were to draw a Phrase Marker that accurately reflects the frequency with which children pause at the three boundaries we examined, it would resemble the following:

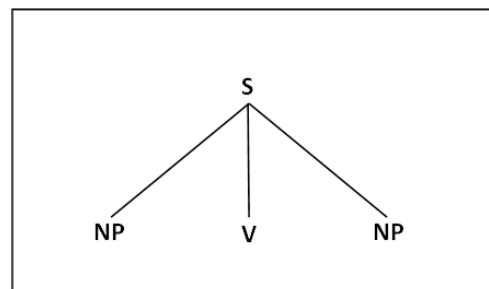

Figure 8. Apparent children’s phrase structure.

Moreover, the significant difference between pauses at the stronger two boundaries and the within-NP boundaries confirms that children do seem to be influenced by an NP constituent, which is also reflected in above the tri-branched Phrase Marker.

Some scholars within the generativist tradition (e.g., Kayne 1994) have claimed that there is a universal syntactic constituency asymmetry between the subject NP and an object NP (i.e., a NP within the VP); and this claimed universality is presumably due to universal grammatical structuring that children must be born with. The current study provides no support for such a hypothesis, and in fact could be interpreted to provide evidence against it.

4.2. Localized Processing Effects on Pausing

Re-visiting the Cooper & Paccia-Cooper (1980) model of language production, we can posit a possible scenario of child language production: it is possible that children do not formulate full grammatical representations of complete utterances prior to speaking. Following the theory of children's processing limitations, if children must process constituents in much smaller units, they may not combine constituents into nested structures. That is, and as our pause frequency data suggest, children may plan each constituent one at a time, in serial order, rather than planning larger syntactic units that contain more than one constituent nested within another. Such a constituent-by-constituent model follows from the fact that children are typically not able to hold as much in memory at a time as are adults.

Evidence from McDaniel et al. (2010) provides further support for the hypothesis that children process sentences in smaller chunks. In particular, they found that adults were more likely to produce restarts in the lower clause of a relative clause construction, whereas children produced restarts throughout the sentence and often returned to points much earlier in the sentence. McDaniel et al. interpreted this result to mean that adults had planned the majority of their utterance with the exception of last-minute details in a lower clause, while children start utterances without having completely worked out their message well enough to formulate a clausal representation. When children lose the thread, they must return to features of the message "in order to recover information that will support detailed local planning (p. 89). Additionally, Redford (2012) showed that while adult pause durations are affected by preceding and subsequent phrase lengths, children's pause duration was not significantly affected, confirming localized planning in children.

However, it should be noted that our data represent pause frequency proportions; at most, the youngest children pause under 20% of the time at any one boundary. Therefore, it may not be completely accurate to suggest that children always plan sentences on a constituent-by-constituent basis. Nevertheless, we suspect children's processing limitations may be broadly interfering with the degree to which grammatical constituent structure influences pause patterns, because children are only able to hold smaller syntactic units in mind during planning phases.

4.3. Information Structure Effects on Pausing

Furthermore, children's observed pause patterns could be influenced by something other than grammatical constituent structure and memory limitations, alone. Some previous study in adult intonation contours and pause groupings confirms that adult pause patterns are sensitive to information structure. Chafe (1987) suggested that in oral speech speakers tend not to plan and hence produce phrases that contain more than one new (i.e. not previously mentally activated) information piece at a time; for example, if both verb and predicate NP are new information, each may occur in its own intonational phrase. Gee and Grosjean (1984) found that adults are more likely to pause before presenting new information than before presenting given information. They recorded adults telling a story and measured pause frequency at sentence breaks. They found the pauses were correlated with plot units of the narrative, whereby pauses occurred most often at the boundaries of narrative sections. Oliveira (2002) performed a similar study, in which 17 spontaneous adult narratives were segmented into speech and silent pauses (more than 250 ms). He found that pause duration increased at narrative unit boundaries—thought to be planning phases—but

pauses decrease in the middle of particular narrative stages (abstract, orientation, complication, evaluation, resolution and coda).

In our study, we have examined pauses within sentences rather than across sentence boundaries and we have not evaluated the data for given versus new status. Even so, if both verbs and predicate NPs tend to contain new information and if children's production is especially sensitive to whether information is already mentally activated (i.e. "given") versus not previously mentally activated (i.e. "new"), then we might predict an equally high incidence of pausing at the V/predicate-NP boundary as at the Subject-NP/V boundary. This pause pattern is exactly what we have found. While adult language and pause patterns show broad effects of information structuring, if children have more limited memory and planning capabilities, information structure issues such as given/new status may play a larger role in their production compared to its impact in adult production—especially within clauses—and we would hypothesize that this would be reflected in the differences in pause phenomena across the age groups.

Finally, it is worth mentioning that our Boundary Strength measurement has collapsed both within-subject NPs and within-predicate NPs into one within-NP category; we did this based on node counts and on traditional theories which hold that any boundary within an NP is less strong than a verb/NP boundary. However, in preliminary data analysis, we did find that children pause significantly more at within-predicate NP sites than at within-subject NP sites. This difference might conceivably be a result of information structure differences (though again, we have not coded the data for given vs. new status): if the information in subject NPs tends to already be activated (i.e. given), then it would require less planning work and we would expect less pausing within such information segments; while if information in predicate NPs is not already activated (i.e. it is new information), more planning effort is required and we would expect more pausing within the elements of the NP. This pattern of pausing is exactly what we have found.

5. Future Directions

To be more confident in our assessment of sentence planning as it influences child pausing and the interaction between information structure and syntax in children over a developmental span, subsequent research will examine pause duration (not just the presence of pause) and compare durations across pause sites—taking into account differences at the two aforementioned within-NP pause sites. If we can uncover a significant difference in pause durations at the specific pause sites we examined in this study, as well as uncover any evidence of a relationship between pause durations prior to utterances and within-clause pause duration, we may accumulate more evidence in support of the important role of information structure in children's pause patterns.

Acknowledgments

This work was supported by Award Number R01HD061458 from the Eunice Kennedy Shriver Institute of Child Health and Human Development (NICHD). The content is solely the responsibility of the authors. The authors would also like to thank the 2009-2010 testing team from the University of Oregon Speech and Language Lab for collecting data, segmenting and transcribing many of the stories.

References

- Abney, Steven. (1992). Prosodic Structure, Performance Structure and Phrase Structure. *Proceedings, Speech and Natural Language Workshop*, 425–428. San Mateo, CA: Morgan Kaufmann.
- Chafe, Wallace. (1987). Cognitive constraints on information flow. *Coherence and Grounding in Discourse*, ed. by Russel Tomlin. Amsterdam: John Benjamins.
- Chomsky, Noam. (1957). *Syntactic Structures*. The Hague/Paris: Mouton.
- Chomsky, Noam. (1965). *Aspects of the Theory of Syntax*. Cambridge, MA: MIT Press.
- Cooper, William E., & Paccia-Cooper, Jeanne. (1980). *Syntax and Speech*. Cambridge, MA: Harvard University Press.
- Ferreira, Fernanda. (1988). *Planning and timing in sentence production: The syntax-to phonology conversion*. Unpublished dissertation, University of Massachusetts, Amherst, MA.
- Ferreira, Fernanda. (1991). Effects of length and syntactic complexity on initiation times for prepared utterances. *Journal of Memory and Language*, 30, 210-233.
- Gee, James Paul, & Grosjean, François. (1983). Performance structures: A psycholinguistic and linguistic appraisal. *Cognitive Psychology*, 15, 411-458.
- Goldberg, Adele. (1995). *A Construction Grammar Approach to Argument Structure*. Chicago: University of Chicago Press.
- Goldman-Eisler, Frieda. (1968). *Psycholinguistics: Experiments in spontaneous speech*. New York: Academic Press.
- Hockett, Charles. (1958). *A Course in Modern Linguistics*. New York: Macmillan.
- Kayne, Richard. (1994). *The Antisymmetry of Syntax*. Cambridge, MA: MIT Press.
- McDaniel, Dana, McKee, Cecile, & Garrett, Merrill. (2010). Children's sentence planning: Syntactic correlates of fluency variations. (2010). *Journal of Child Language* 37, 59-94.
- McKee, Cecil & McDaniel, Dana. (2001). Resumptive pronouns in English relative clauses. *Language Acquisition* 9, 113–56.
- Nespor, Marina, & Vogel, Irene. (1986). *Prosodic Phonology*. Dordrecht: Foris Publications.
- Oliveira, Miguel. (2002). Pausing strategies as means of information processing narratives. In *Proceedings of the International Conference on Speech Prosody*, Aix-en-Provence, France, 539–542.
- Radford, Andrew. (1988). *Transformational Grammar: A first course*. New York: Cambridge University Press.
- Redford, Melissa A. (2012). A comparative analysis of pausing in child and adult storytelling. *Applied Psycholinguistics*. DOI:10.1017/S0142716411000877.
- Selkirk, Elisabeth O. (1984). *Phonology and Syntax: The Relation Between Sound and Structure*. Cambridge, Mass.: MIT Press.
- Wagner, Michael. (2005). *Long distance effects on prosody*. Poster presented at the 18th Annual Meeting of the CUNY conference on Human Sentence Processing. Tucson, Arizona.
- Watson, Duane & Gibson, Edward. (2004). The relationship between intonational phrasing and syntactic structure in language production. *Language and Cognitive Processes*, 19, 713-755.